

# 25000N series

Professional slide switches



## DISTINCTIVE FEATURES

Professional grade slide switches for PC boards

Approved according to UL 1054

Wave solderable

Available with flush, high and side actuator

Various actuator lengths



## ELECTRICAL SPECIFICATIONS

- Max. current/voltage rating with resistive load :
  - silver contacts (A) : 1 A 30 VDC
  - gold plated brass contacts (LD) : 100 mA 30 VDC
- Minimum load :
  - silver contacts (A) : 100 mA 10 V
  - gold plated brass contacts (LD) : 10  $\mu$ A 5 VDC - 10 mA 50 mV
- Initial contact resistance :
  - silver contacts (A) : 10 m $\Omega$  max.
  - gold plated brass contacts (LD) : 50 m $\Omega$  max.
- Insulation resistance : 1,000 M $\Omega$  min. at 500 VDC
- Dielectric strength :
  - 1,000 Vrms 50 Hz min. between terminals
  - 2,000 Vrms 50 Hz min. between poles
  - 2,000 Vrms 50 Hz min. between terminals and frame
- Electrical life : 10,000 cycles at full load
- Low level or mechanical life : 20,000 cycles



## GENERAL SPECIFICATIONS

- Operating temperature : -40 °C to +85 °C (-40 °F to +185 °F)
- Hand soldering : 380°C to 390°C, max 3s, with an alloy 99% Tin
- Overall length : 14 mm (.551)
- Actuator height (outside case) :
  - high : 2.80 mm (.110)
  - extra high : 6 mm (.236)
  - side : 2.30 mm (.090)
  - long side : 6 mm (.236)
- Travel : 4 mm (.157)

The company reserves the right to change specifications without notice.

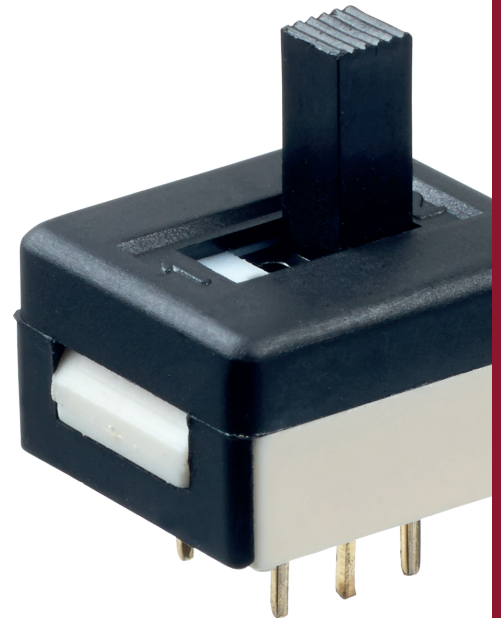

# 25000N series

Professional slide switches



## MATERIALS

- Case : PBT
- Actuator : polyamide, glass filled
- Cover : polyamide, glass filled
- Contacts
  - A : silver
  - LD : brass, gold plated
- Terminal seal : epoxy



## POSITIONS AND CONNECTIONS

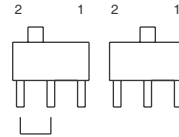

Function 6 : ON - ON  
Function 9 : ON OFF ON

## AGENCY APPROVAL



2 A 250 VAC  
4 A 125 VAC

**Availability** : consult factory for details of approved models.

**Marking** : to order switches marked UL, complete the "Options and Approvals" box of ordering format.



## ELECTRICAL FUNCTIONS



## PCB MOUNTING

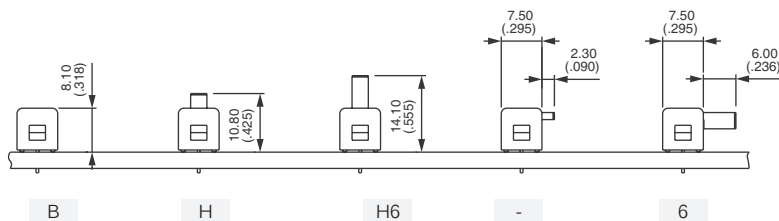

# 25000N series

Professional slide switches



## BUILD YOUR PART NUMBER

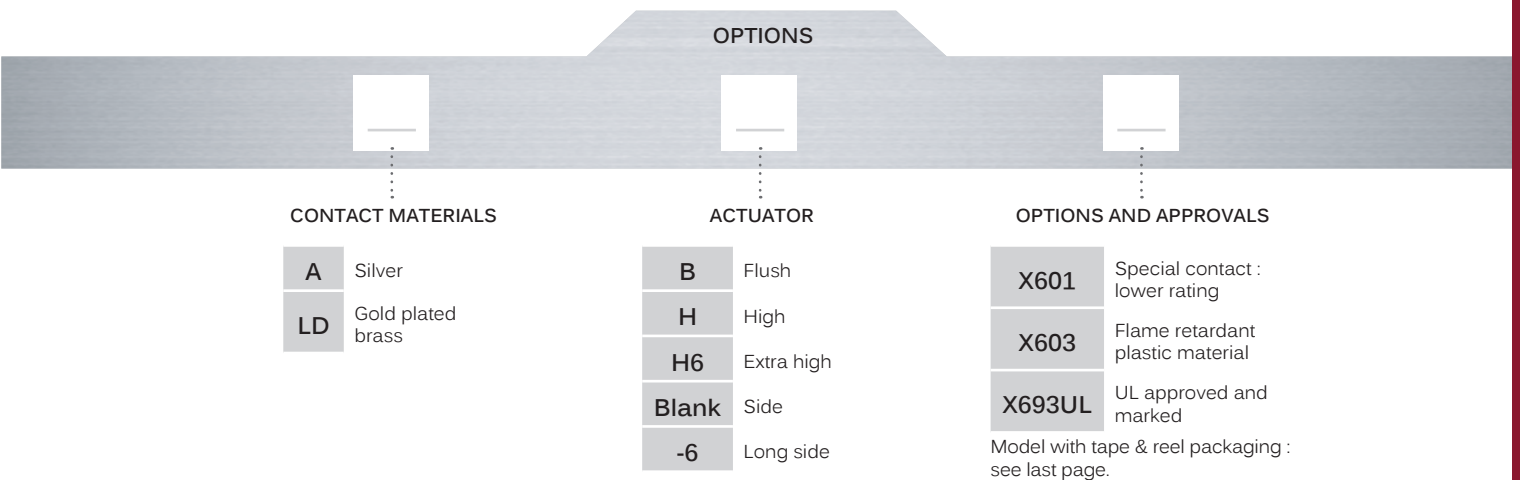
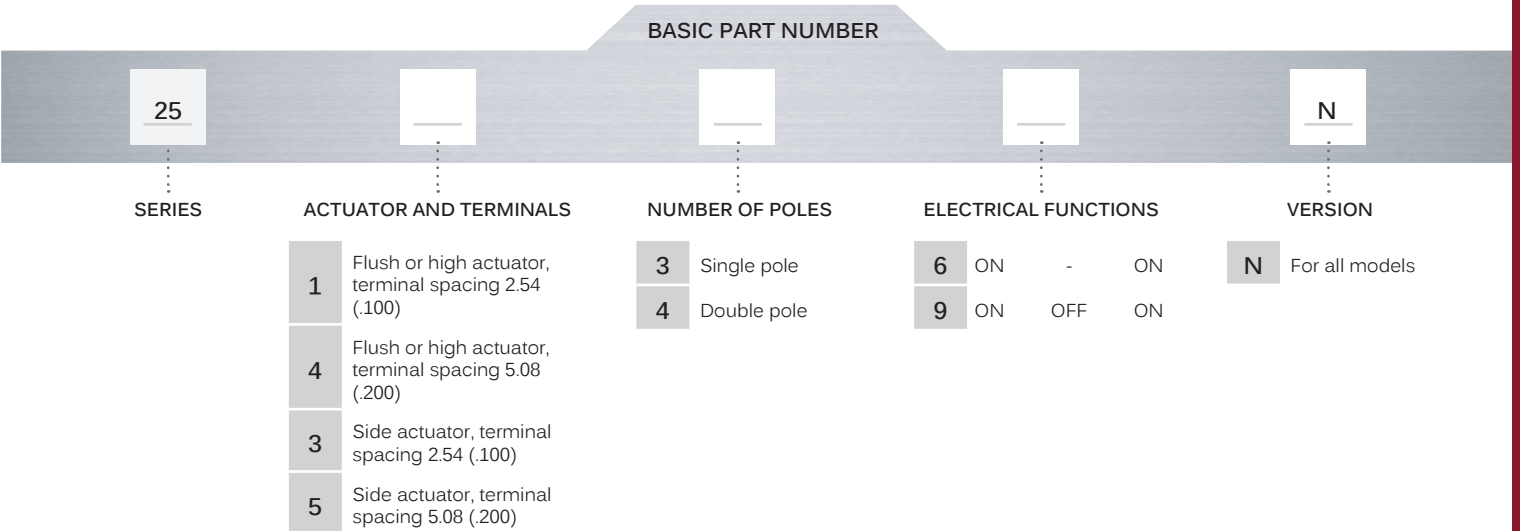

## ABOUT THIS SERIES

On the following pages, you will find successively basic part numbers of switches and options in the same order as in above chart.

**Notice :** please note that not all combinations of above numbers are available. Refer to the following pages for further information.

# 25000N series

Professional slide switches

## FLUSH ACTUATOR : 25000NB



Terminal spacing  
2.54 (.100)

Single pole

25136N B

25139N B

Double pole

25146N B

25149N B

Terminal spacing  
5.08 (.200)

Single pole

25436N B

25439N B

Double pole

25446N B

25449N B

## HIGH ACTUATOR : 25000NH



Terminal spacing  
2.54 (.100)

Single pole

25136N H

25139N H

Double pole

25146N H

25149N H

Terminal spacing  
5.08 (.200)

Single pole

25436N H

25439N H

Double pole

25446N H

25449N H

## EXTRA HIGH ACTUATOR : 25000NH6



Terminal spacing  
2.54 (.100)

Single pole

25136N H6

25139N H6

Double pole

25146N H6

25149N H6

Terminal spacing  
5.08 (.200)

Single pole

25436N H6

25439N H6

Double pole

25446N H6

25449N H6

## SIDE ACTUATOR : 25000N



Terminal spacing  
2.54 (.100)

Single pole

25336N

25339N

Double pole

25346N

25349N

Terminal spacing  
5.08 (.200)

Single pole

25536N

25539N

Double pole

25546N

25549N

Shown with 2.54 mm terminal spacing

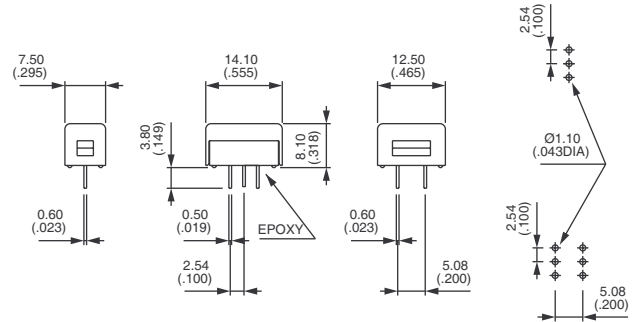

Shown with 5.08 mm terminal spacing

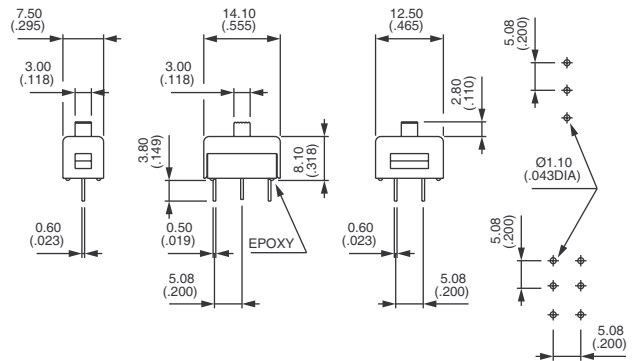

Shown with 5.08 mm terminal spacing

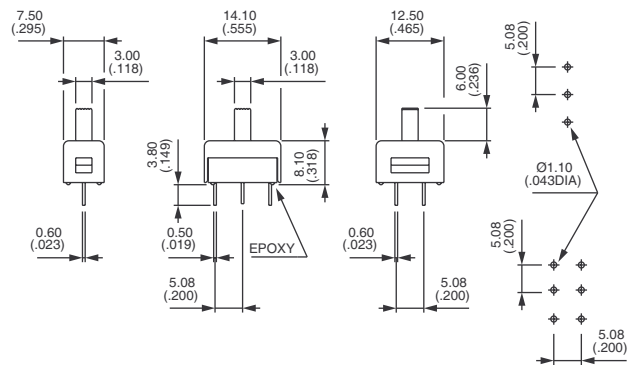

Shown with 2.54 mm terminal spacing

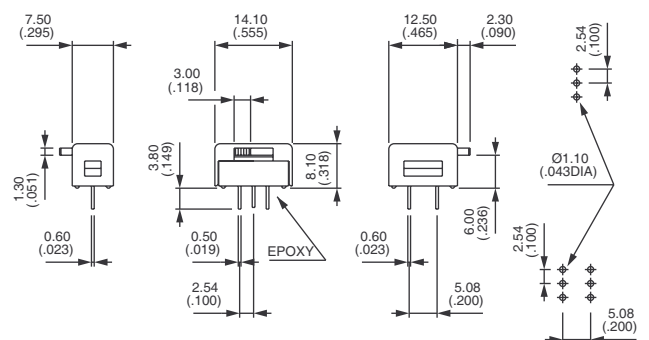

# 25000N series

Professional slide switches

## LONG SIDE ACTUATOR : 25000N-6



Terminal spacing 2.54 (.100)	Terminal spacing 5.08 (.200)
Single pole	Single pole
25336N -6	25536N -6
25339N -6	25539N -6
Double pole	Double pole
25346N -6	25546N -6
25349N -6	25549N -6

Shown with 2.54 mm terminal spacing

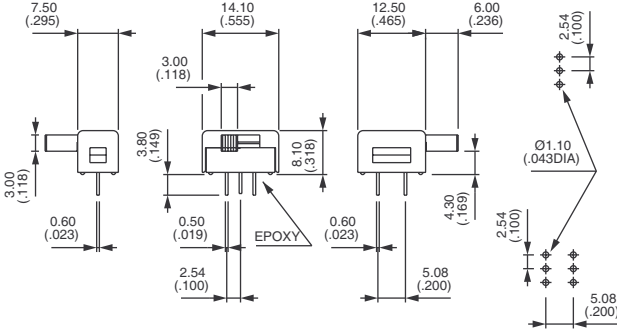

### CONTACT MATERIALS



- A Silver
- LD Brass, gold plated

### ACTUATORS

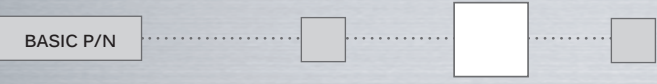

- B Flush actuator
- H High actuator
- H6 Extra high
- Blank Side
- 6 Long side

### OPTIONS AND APPROVALS

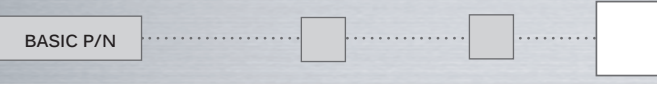

- X601 Silver plated brass contacts - Lower rating 3 VA 30 VDC. Min quantity : 5,000 pieces per model and shipment.
- X693 Flame retardant plastic materials
- X693UL Switches approved and marked UL (silver contacts only)

## MODEL WITH TAPE AND REEL PACKAGING

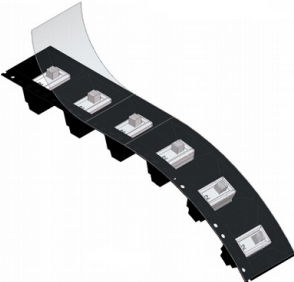

25436NLDH X693-02 R  
On request.